

VS7550 UV Only Mini Spectrograph

Operating Manual



Table of Contents

[Table of Contents](#)

[Overview](#)

[Specifications](#)

[Vacuum Interface](#)

[Software and Drivers](#)

[Packing List](#)

[Quick Start Operating Procedure](#)

[Optional KrLM Mini Light Source](#)

[Troubleshooting](#)

[VS7550 Electronics Pinouts](#)

[Appendix](#)

[Spectra](#)

[Contact](#)

Overview

	Description
<p style="text-align: center;">VS7550</p> 	<p>VUV to NIR Mini-Spectrograph</p> <p>The VS7550 is a miniature Czerny-Turner spectrograph with excellent speed, spectral range and spectral resolution with software control of slit size, input f#, order sorting filters, grating angle and dark exposures. For VUV operation, the spectrograph has a UHV window and laminar flow purge system, which allows operation down to the window short wavelength cut-off (112 nm for MgF2). The spectrograph is small enough to fit in your hand and can be fully operational in any orientation. Accessories include a built-in spectral calibration lamp, a multi-spectral field flat light source and low-cost accessories such as telescopes, vacuum adapters, and flow controllers.</p>

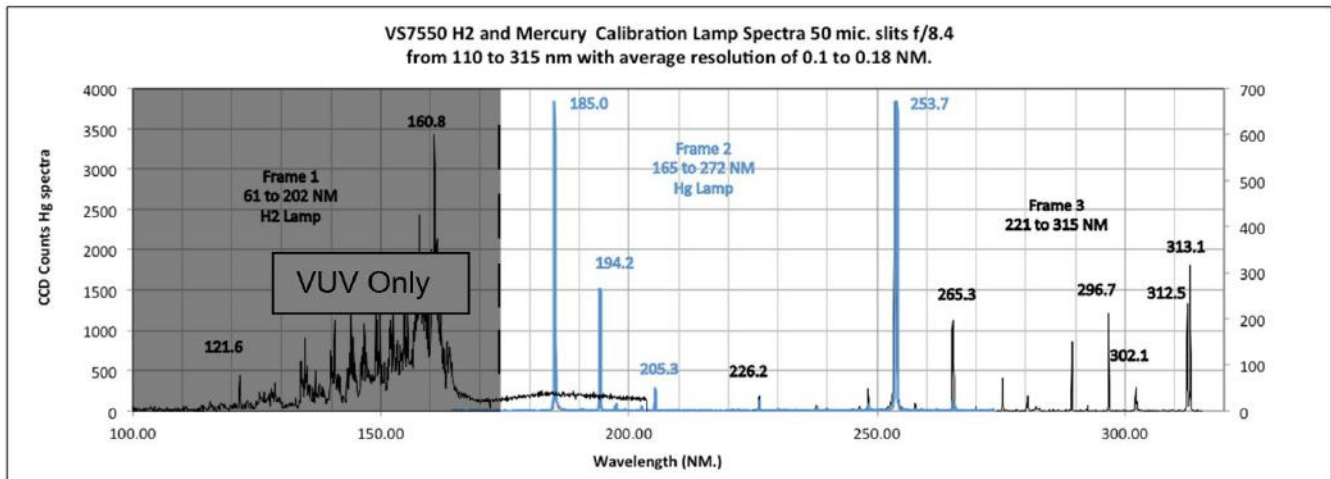

Specifications

Electrical/Optical				
Specification	Minimum	Typical/ Median	Maximum	Units
Focal Length (input)	76.0	76.2	74.44	mm
Focal Length (output)	41	46	48	mm
Wavelength Range (1200)	104	-	1040	nm
Wavelength range (1800)	104		520	nm
Wavelength Range (3600)	104	-	340	nm
Wavelength Accuracy (1200)		±0.35		nm
Wavelength Accuracy (3600)	-	±0.12	-	nm
CCD QE 110 - 400nm	10	18	20	%
CCD QE 400 - 930nm	15	34	42	%
CCD QE 930 - 1050nm	3	12	15	%
Resolution 1200 25 mic f3.2	0.4	0.66	1	nm
Resolution 2400 25 mic f3.2	0.2	0.33	0.5	nm
Resolution 3600 25 mic f3.2	0.13	0.22	0.27	nm
Available Gratings	From 600 to 4200 grooves per mm			
Software selectable slits, order masks and dark shutter	25, 50, 100, 200, 400 microns			
Software selection of spectral range	3600 l/mm grating 110 to 315 (2 steps) 1200 l/mm grating 104 to 1040 (4 steps)			
Software selection grating aperture	Effective range of f# 3.2 to 8.4			
Detector	2048 pixel linear array with VUV/UV phosphor			
UHV option	Window adapter with 2.75" Conflat™ flange			
Connection	Two USB 2.0 cables for data, power and servo control			

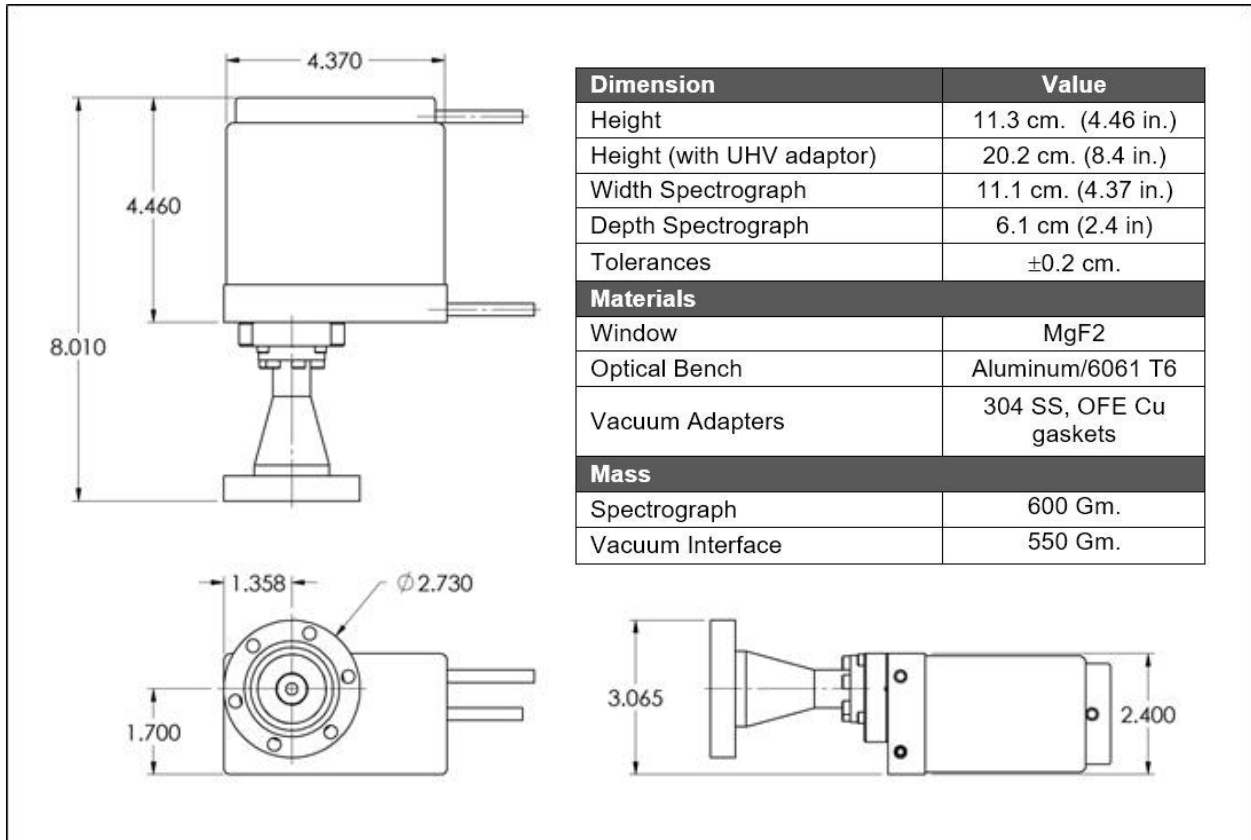

Thermal				
Non-operational Temp. Range	-20	22	70	°C
Temp. Range of vacuum flange plus window	-50	22	220	°C
Ultimate vacuum of adapter	1e-14	1e-10	1e-9	mbar
Electrical				
System Power Source (USB HUB)	USB 2.0			
Current consumption	<500 mA			

Vacuum Interface

Front 2.75 in flange can be attached to UHV chamber. Spectrograph is isolated with MgF2 window in vacuum adapter. Purge can be dry N2, Ar, or He.

The Spectrometer can be removed from a vacuum chamber without breaking vacuum. This allows bake out of the UHV chamber above the non-operational limit of the spectrometer.

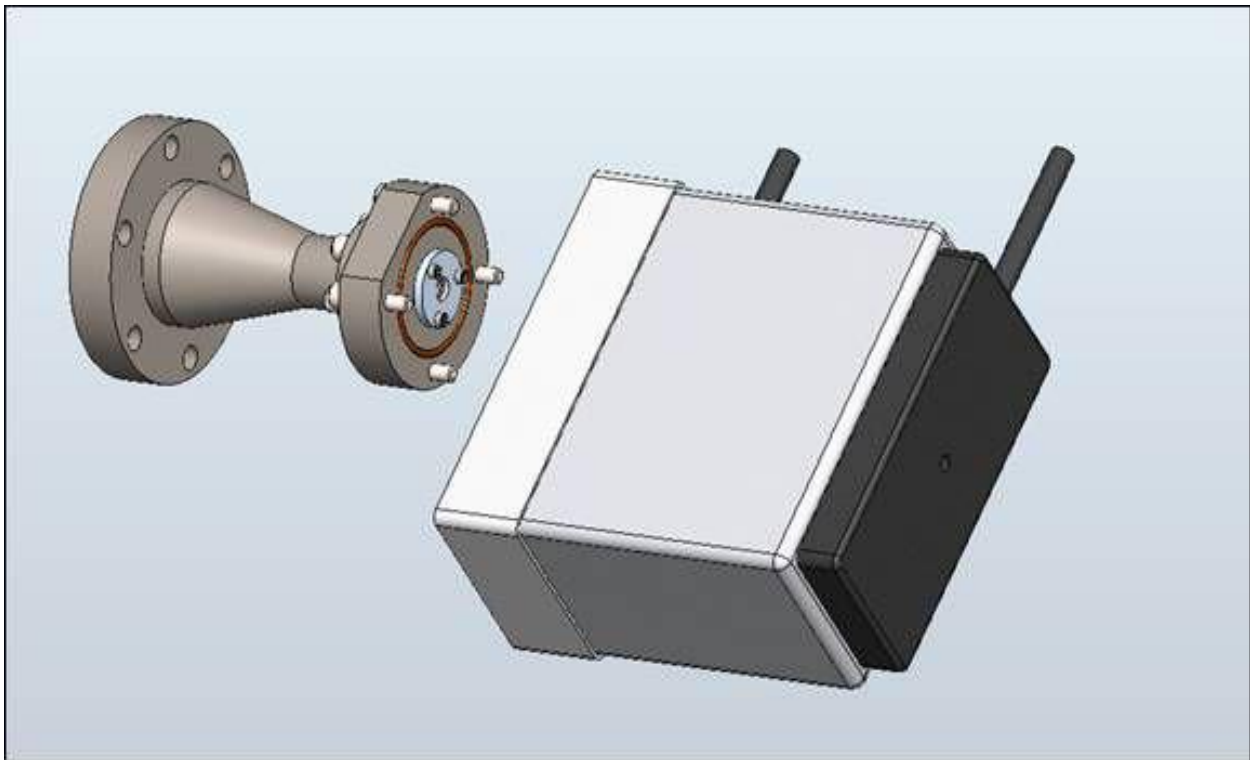

Software and Drivers

A PC software package which controls all the spectrometer functions, displays and stores spectral data is provided.

Capabilities include:

- Changing all CCD parameters (wavelength coefficients, integration time)
 - Slit width control
 - Spectrograph wavelength range control.
 - Spectrograph input aperture (input f#)
 - Spectrograph order sorting filter
 - Pixel or Wavelength Display
 - Software activated darks
 - Data export (XLS User selectable)
 - Store multiple spectra and graph/save multiple spectra
-

Packing List

Item	Description	QTY
VS7550	VUV/UV Spectrometer with CF adaptor	1
USB Cables	USB Cable set	1
Electronics	Laptop with software	1
O-Rings & Gaskets	Spare O-rings & CF gaskets	1

Quick Start Operating Procedure

1. Connect PC to Spectrograph

- a. Plug USB cables into USB ports on the PC and into spectrograph.
- c. Start VS7550 Spectrometer Software.

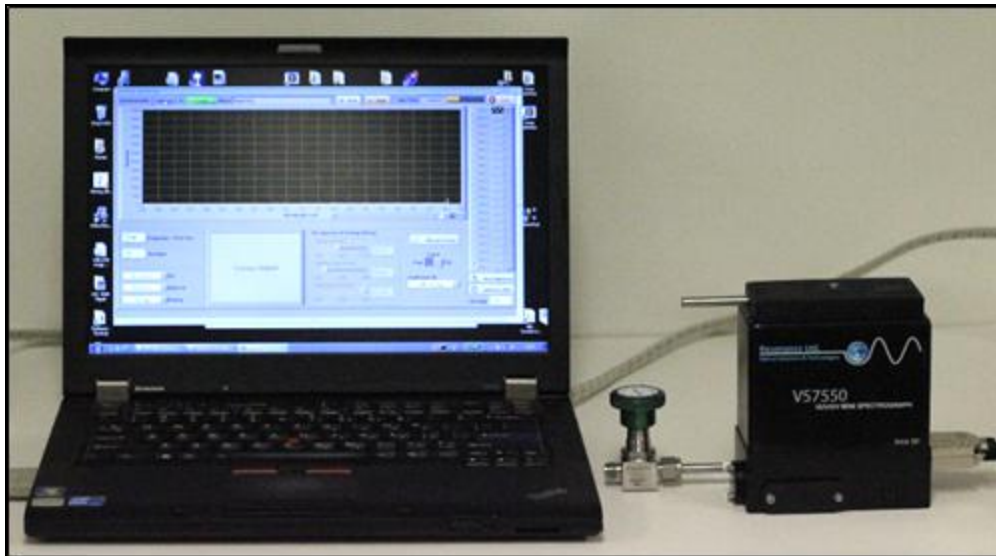

2. Set-up Software for Taking Spectra

- a. Make sure manual settings button is unchecked (this should be set by default). By checking the manual settings button you can fine tune slit, aperture and grating positions (it is highly recommended to leave these settings as they have been optimized for this specific unit).
- b. Select slit size from drop down menu. Slit settings determine resolution. See graph in appendix. 50microns is good for most applications.
- c. Set grating angle from drop down menu from 4 to -30 degrees. Most common grating angles are in the first 5 positions. The grating angle menu also has order sorting filters assigned to angles. VUV (open) are for wavelengths between 100nm and 230nm. The UV/Vis (quartz) are for wavelengths between 230nm and 320nm. The VIS/IR (IR) are for wavelengths between 320nm and 1000nm. When observing VUV make sure VUV (open) angle is selected.
- d. Set aperture from drop down menu (for highest resolution use f8.4, for intermediate resolution use f4.8 and for highest sensitivity use f3.2) Select integration time to input value, integration time 100ms; select averages, input 5 averages.
- e. After above steps have been carried out spectra will be continuously displayed after every integration time as seen with progress bar at top right of window.

3. Operation During Spectral Acquisition

- a. Adjust integration time and averages while observing target. Most applications can use integration times of 100ms with 5 averages. To ensure good linearity maintain the region of interest below 3500 counts. Take dark (click the Dark button near the top mid-right of program). Wait for dark acquisition, then click the “-Dark” button. **Dark must be taken at beginning of session and after every change to integration time for the best possible results.**
- b. Wavelength/Pixel - you may change the view of the signal as wavelength or as pixel values. When changing between these two modes be sure to auto scale the graph by right clicking on graph and selecting “auto scale x” and/or “auto scale y” to ensure the signal is viewable.

4. Storing and Saving Data

- a. The “Store Spectrum” button saves spectrum into temporary storage. Any selected stored plot is visible on screen.
- b. “Full Spectrum” scan will record an automatic set of spectrum at predetermined angles.
- c. Stored plots can be saved and exported via right clicking on the spectrum window and selecting export spectra. There are 3 ways to save spectra: Single Plot (select a single plot to save), Selected Plots (saves all visible plots) and All Plots (saves all plots).
- d. Data is saved as a CSV format and can be opened in Excel.
- e. We advise you to save and delete after every 100 spectra to avoid cumbersome worksheets. BE SURE “ALL PLOTS” IS SELECTED IF SAVING ALL SPECTRA. Note that single plot will only save the current spectrum plot if no other plot is selected.

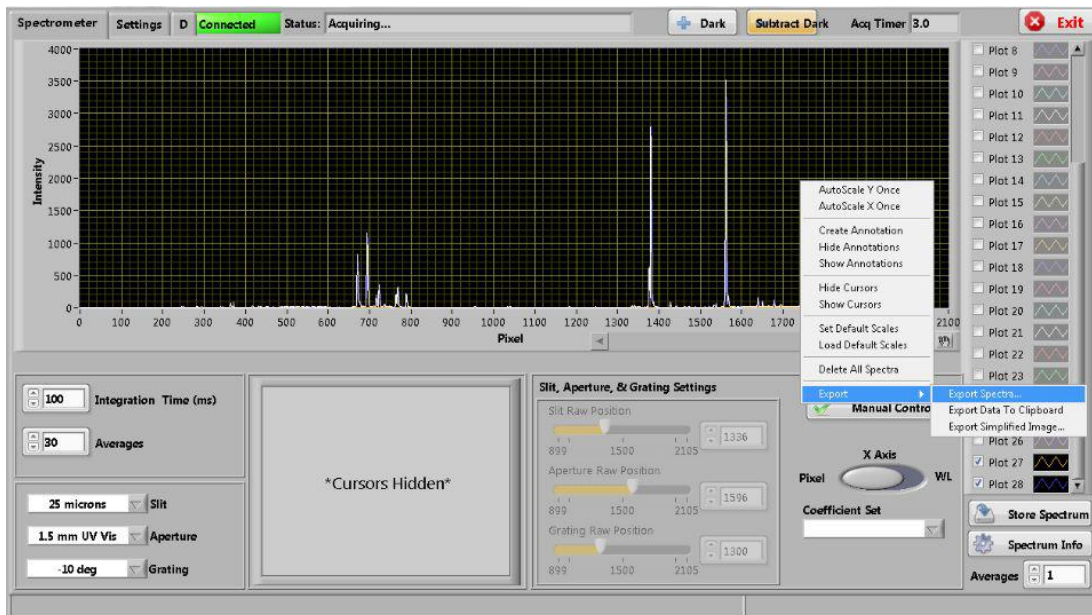

Software UI

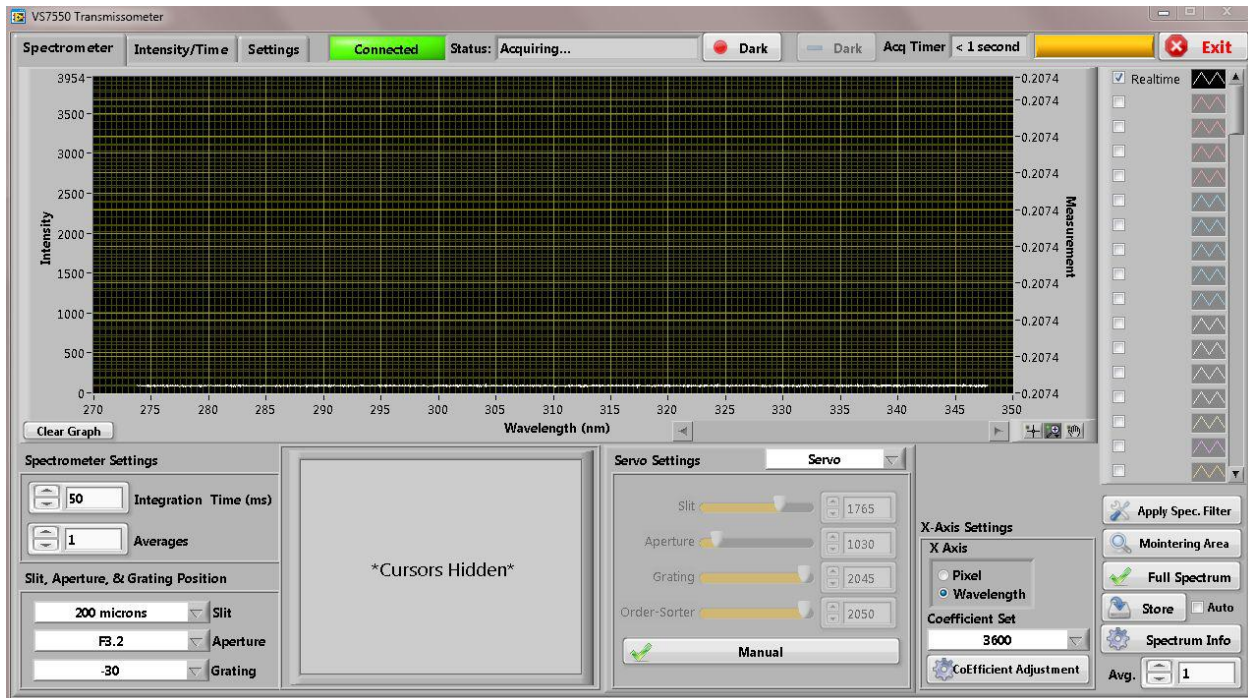

Right clicking on the spectrometer tab window in the graph area will bring up a drop down menu. Here there are options for manipulating and viewing different aspects of the displayed signal.

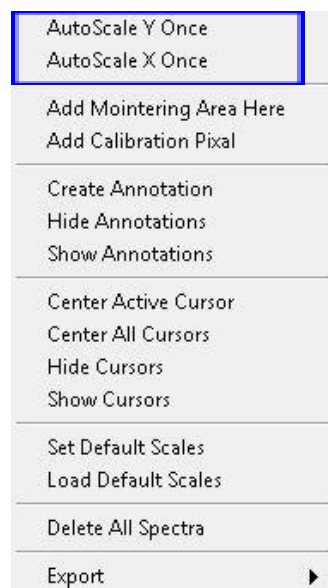

AutoScale Y Once - Fits the y-axis to display the current signal at the minimum and maximum intensity. This is useful to select at the beginning of every session to ensure there is a signal present.

AutoScale X Once - Fits the x-axis to display the current signal. This is useful to select at the beginning of every session to ensure there is a signal present.

Important: This option will need to be selected at every grating angle change (unless the range is wide enough to include multiple angles) .

To change the graph scales manually, double click either the minimum and/or maximum value and input a new value.

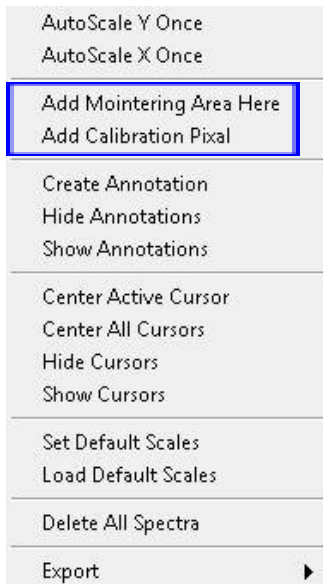

Add Monitoring Area Here - Creates a center point of reference for Intensity/Time (can be viewed and parameter changes can be made in the Intensity/Time tab at the top of the UI window) readings. A pop-up window will prompt you to input a range to monitor and which signal (pixel/wavelength) to record.

Add Calibration Pixel - Records current cursor position of pixel for the Coefficient Adjustment calculator.

Warning: It is highly recommended not to use the Coefficient Adjustment calculator as the VS7550 has been pre-calibrated. Only use this if you are fully aware of the affects or have assistance from a Resonance Ltd. technician.

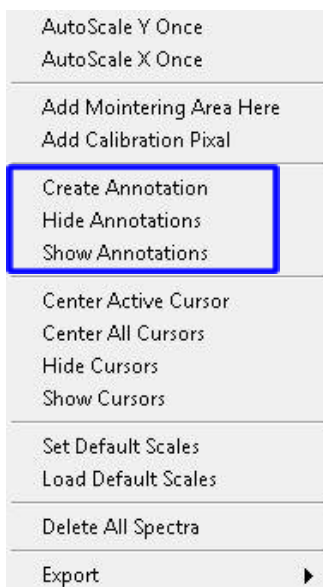

Create Annotation - Create an annotation box onto a stored spectrum. A pop-up window allows you to input an annotation, select its color and assign it to a specific stored spectrum. Any created annotation(s) will be recorded with its corresponding spectra upon saving spectrum data.

Hide Annotations - Hides the currently displayed annotation(s).

Show Annotations - Shows current annotation(s) that have been hidden.

Note: Any annotations created during the session will be deleted upon closing of the VS7550 software.

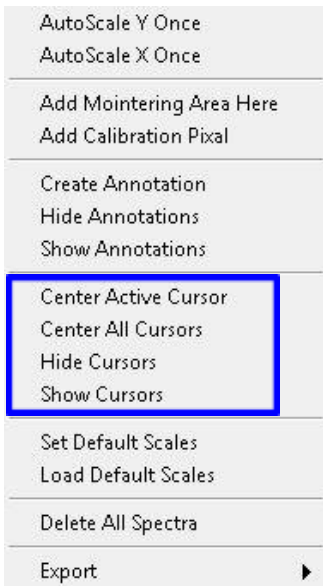

Center Active Cursor - Positions the currently active cursor to the center along the x-axis of the graph window.

Center All Cursors - Positions all cursors to the center along the x-axis of the graph window.

Hide Cursors - Hides all currently displayed cursors.

Show Cursors - Displays cursors in the graph window.

Note: Cursors are hidden by default. When cursors are shown, they will appear in the graph window and also their corresponding information will be displayed in the cursor window below the graph.

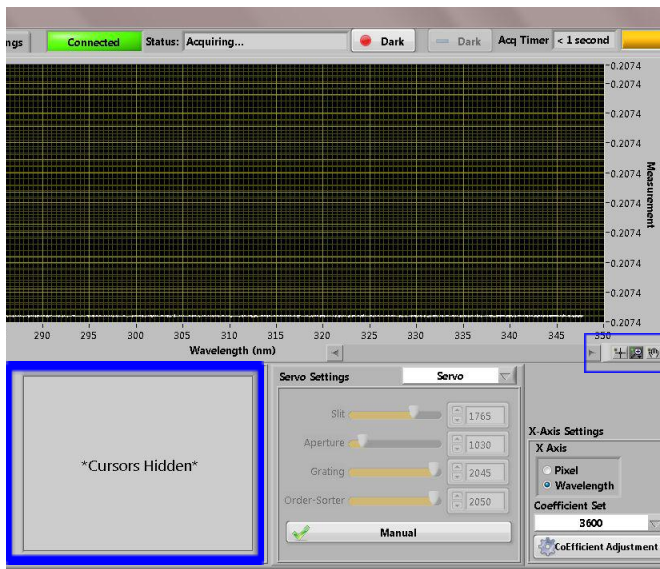

The graph tools bar will allow you to move the cursors around the window or a designated spectra. Be sure to select the “cross hair” icon to manipulate the displayed cursors.

Cursors:	X	Y
Cursor 0		
Plot 1	162.799	99
Cursor 1	135	2457
Cursor 2	132.428	1709

The cursor window will display cursor information once “Show Cursors” has been selected. Here you may view individual cursor positions. Right clicking on a cursor name will provide more options for viewing cursors.

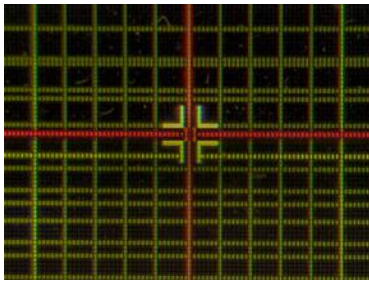

To move a single cursor, place the pointer at the intersection point of the cursor until the pointer displays the cross hair (displayed in the picture) and click and drag. You may also change only the vertical or horizontal position by clicking and dragging the corresponding cursor line.

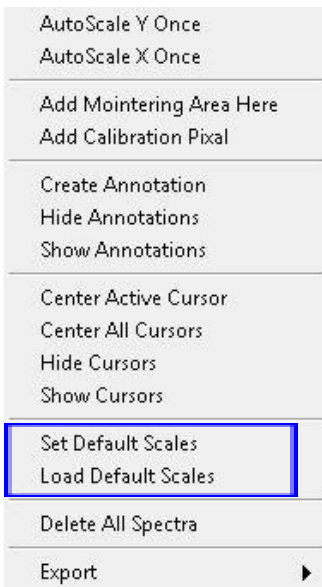

Set Default Scales - Sets the current graph x and y scales as default. To change the graph scales, double click either the minimum and/or maximum value and input a new value.
Important: If you want to retain the values used for a specified default scale for the next session, it must be saved by going to the Settings tab and “Save” settings.

Load Default Scales - Returns the graph x and y scale to the previously saved default values.

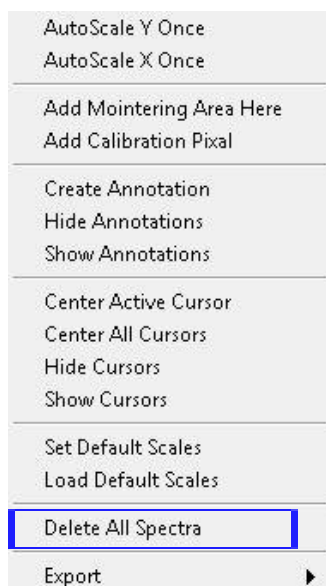

Delete All Spectra - Deletes all stored spectrum taken during the current session.
Important: Be sure to save any spectra you want to keep before selecting, there is no way to recover any deleted spectra!

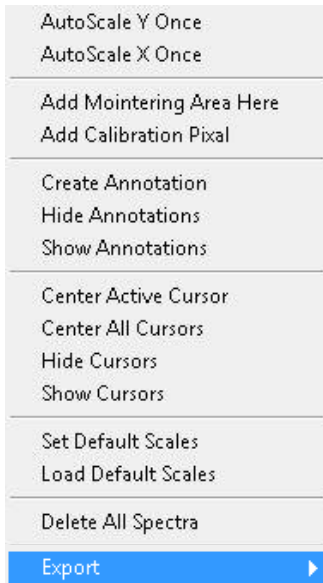

Export Spectra - Provides save options for the current session. You may save single, visible or all plots (stored spectra) to disk. Click the file folder icon to specify a specific save path. Here you may also input a file name/description.

Export Data to Clipboard - Saves to the computer clipboard for temporary file viewing.

Export Simplified Image - Provides options to save an image of the current graph window and stored spectrum list.



Optional KrLM Mini Light Source

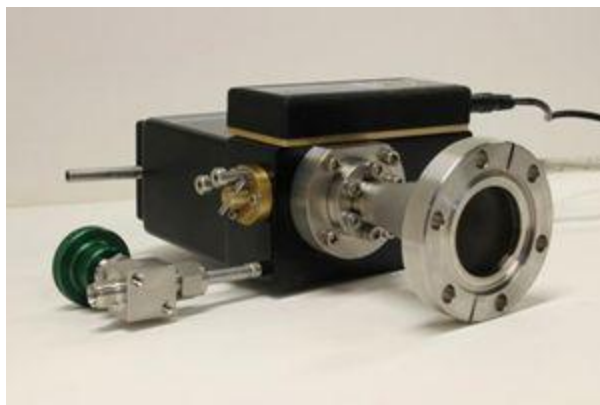

VS7550 with optional KrLM Mini Light Source

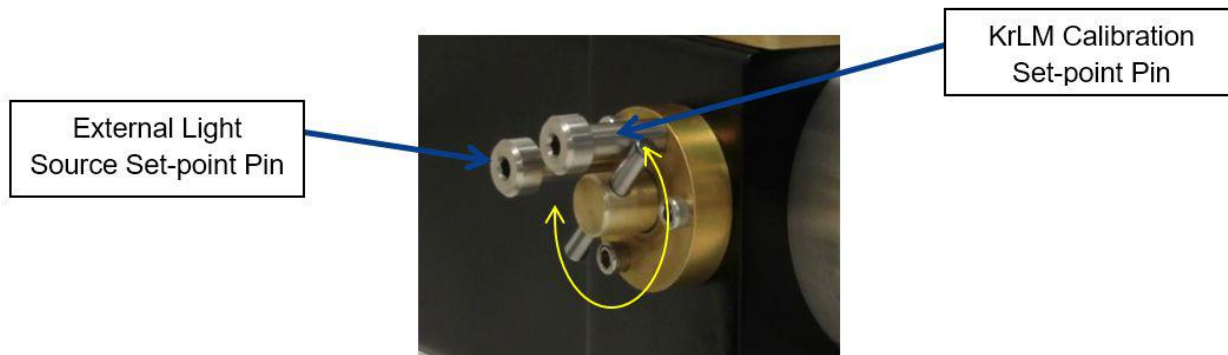

Rotate the spindle to switch between the KrLM mini light source and external light source.

KrLM Mini Light Source (for calibration)

- Rotate spindle counter-clockwise until it touches the top-right pin (see above picture)
- Switch on light source by connecting DC power supply to lamp and AC outlet.
- If purge is off, no spectrum will be seen below 400nm. If purge is on, first and second order VUV spectra will be visible. (see Kr Cal Lamp spectrum next page)
- Follow operating procedure to view and obtain spectra.

External Light Source (standard operation)

- Rotate spindle clockwise until it touches the left pin.
- Follow operating procedure to view and obtain spectra.

Troubleshooting

Software has lost connection to spectrometer

A prompt will appear if connection between the VS7550 and software has been lost. This may be caused by a loose USB connection. Also, depending on the proximity of the VS7550 to a strong electric current it may also cause disconnection. To remedy this, simply ground the VS7550 case. Connecting a grounding cable to the purge inlet will suffice. Close the dialog box, then click the “Exit” button (top right corner of window). If there is data that needs to be saved do so before clicking the “Exit” button.

Unable to see Spectrum

There are a number of contributing factors that may lead to the inability to see spectrum. In VUV, air in optical path. Check purge and vacuum.

In all spectrum, check order sorter filter.

Check slit size and integration time. Set to 100 microns and 1000 ms integration time as an initial test for spectrum.

Check pixel and auto scale X and Y, be sure the graph scale is wide enough to view. Right clicking on graph and selecting “auto scale x” and/or “auto scale y” will ensure the signal is on scale and viewable.

VS7550 Electronics Pinouts

9-pin DSUB Connector

Pin	Label	Colour
1	Spec USB +5V	Red
2	Spec USB GND	Black
3	Spec USB D+	Green
4	Spec USB D-	White
5	NC	
6	Arduino USB +5V	Red
7	Arduino USB GND	Black
8	Arduino USB D+	Green
9	Arduino USB D-	White

Arduino Nano

Pin	Label	Assignment
1	D1/Tx	
2	D0/Rx	
3	RESET	
4	GND	Servo GND
5	D2	
6	D3	
7	D4	
8	D5	
9	D6	
10	D7	
11	D8	Servo 4 PWM (Order Sorter)*
12	D9	Servo 1 PWM (Slits)*
13	D10/CS	Servo 2 PWM (Apertures)*
14	D11/MOSI	Servo 3 PWM (Grating)*
15	D12/MISO	
16	D13/SCK	
17	3V3	
18	AREF	
19	A7	
20	A6	
21	A5	
22	A4	
23	A3	
24	A2	
25	A1	
26	A0	
27	+5V	
28	RESET	
29	GND	Servo GND
30	VIN	

*10k pull-down resistor needed on PWM servo outputs

Appendix

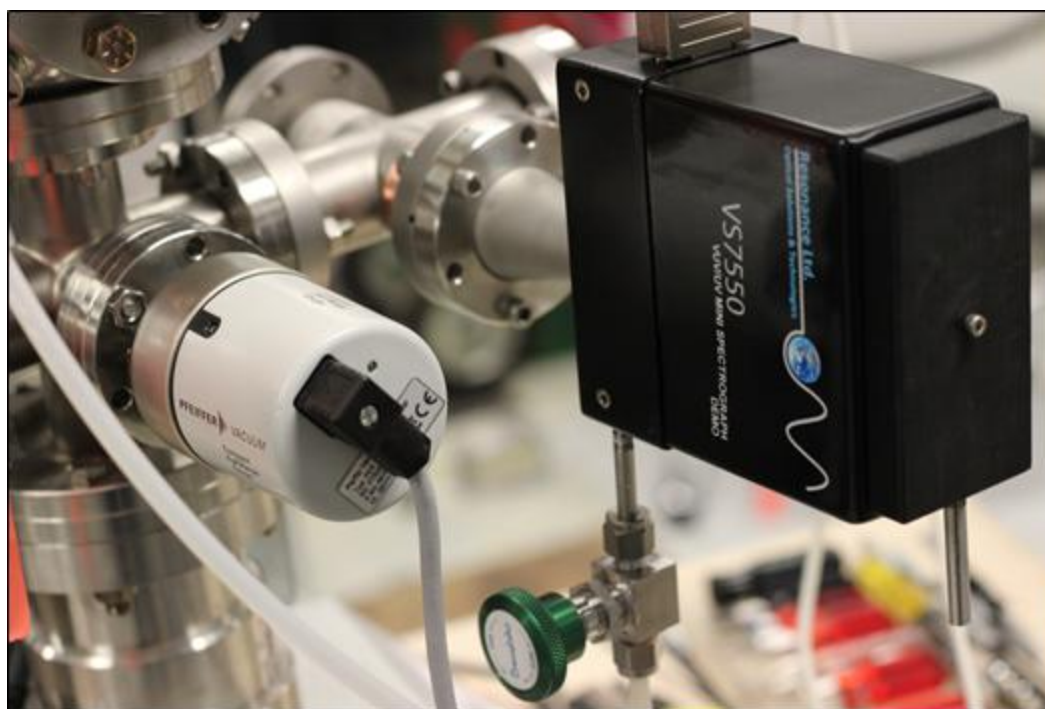
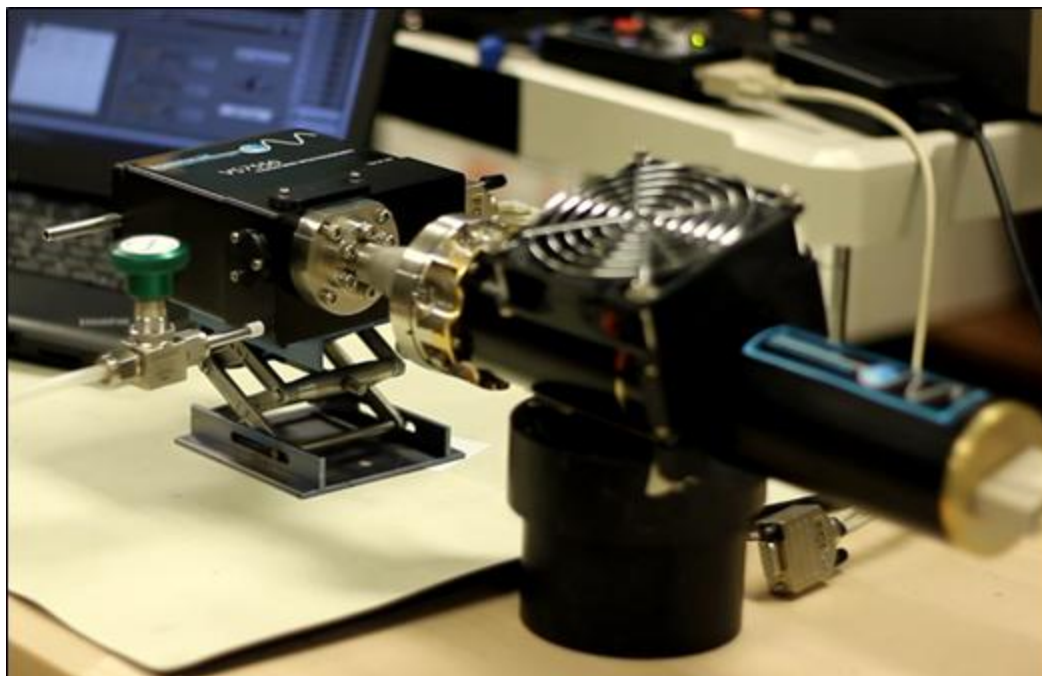

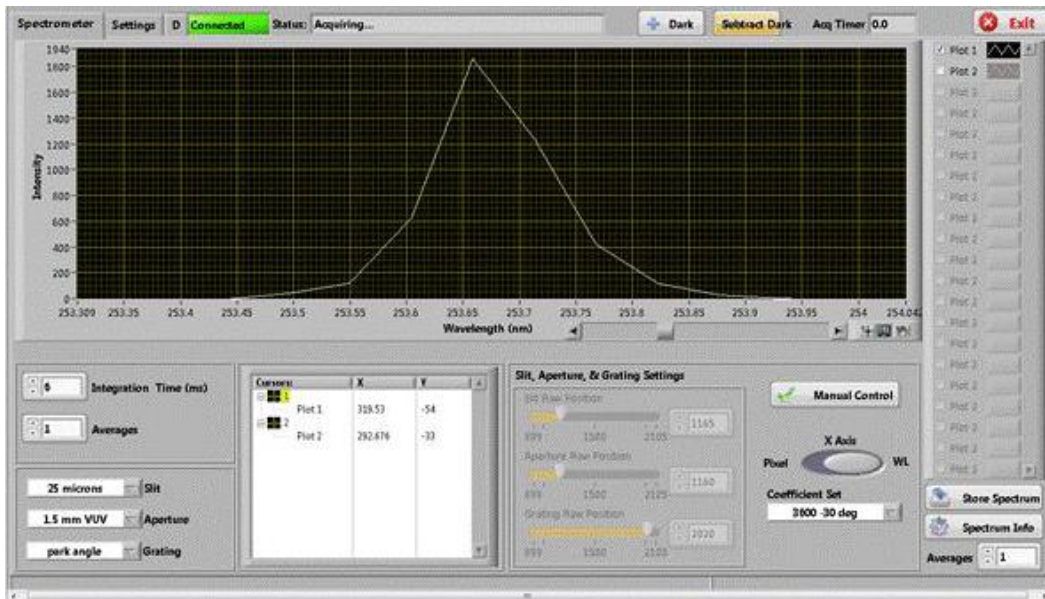

Resonance acquisition software showing magnified region at 253.7nm

Spectra

UV/VUV Spectrum with VS7550
4 frames with 2880 g/mm grating

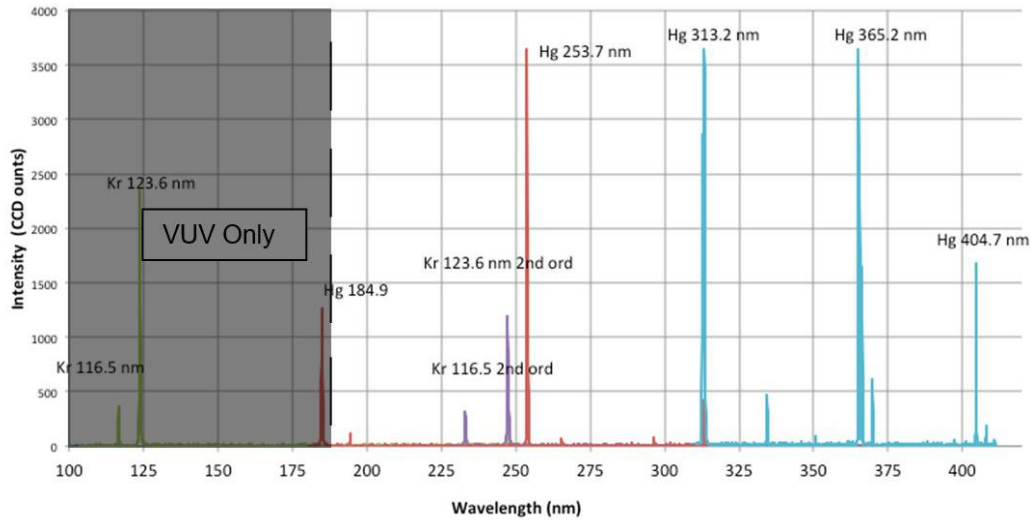

VS7550 viewing Schumann-Runge O2 Absorption Bands
Conditions: Resonance H2 light source, 50 micron slits, f/8.4 aperture
10 sec integration time, 1 average with Flat field correction 25 cm air path

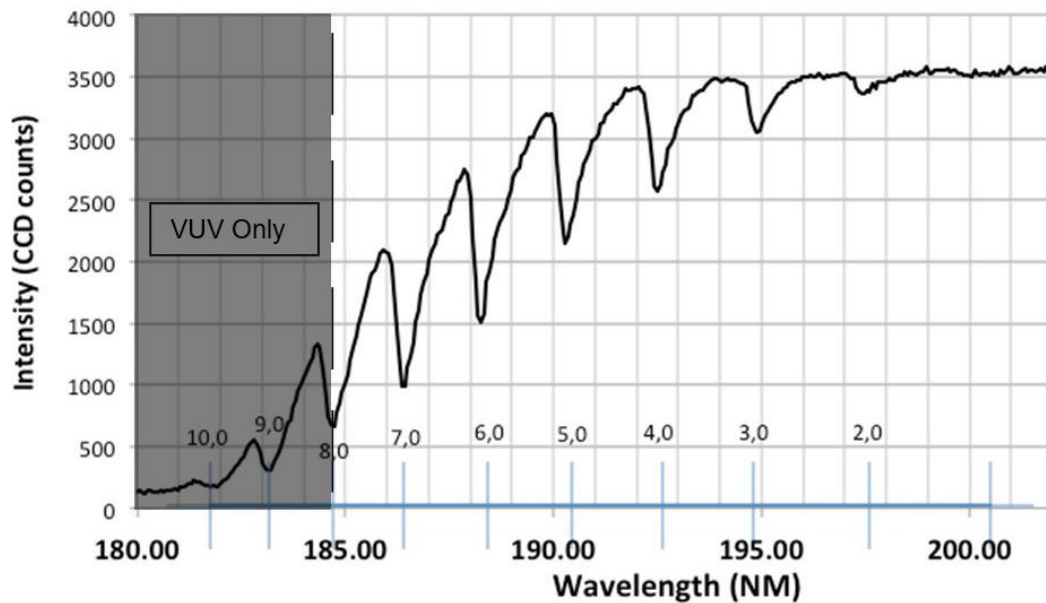

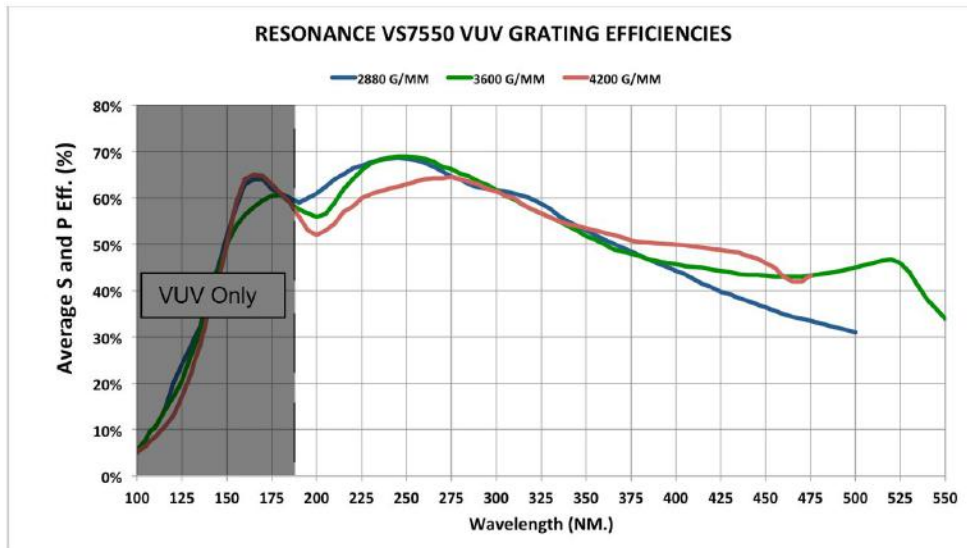
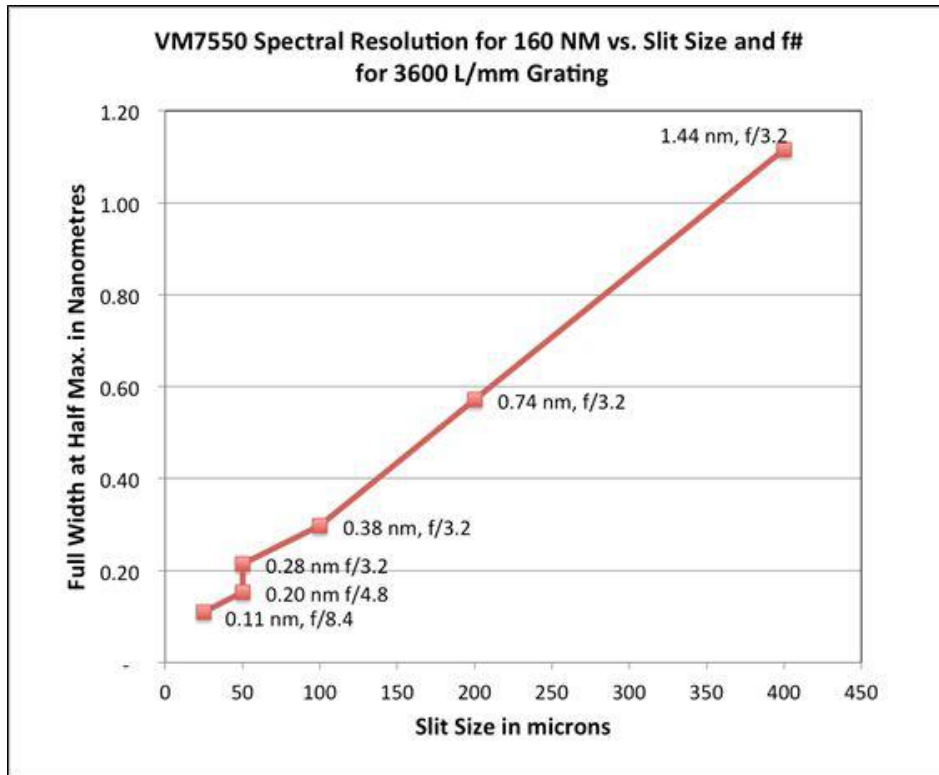

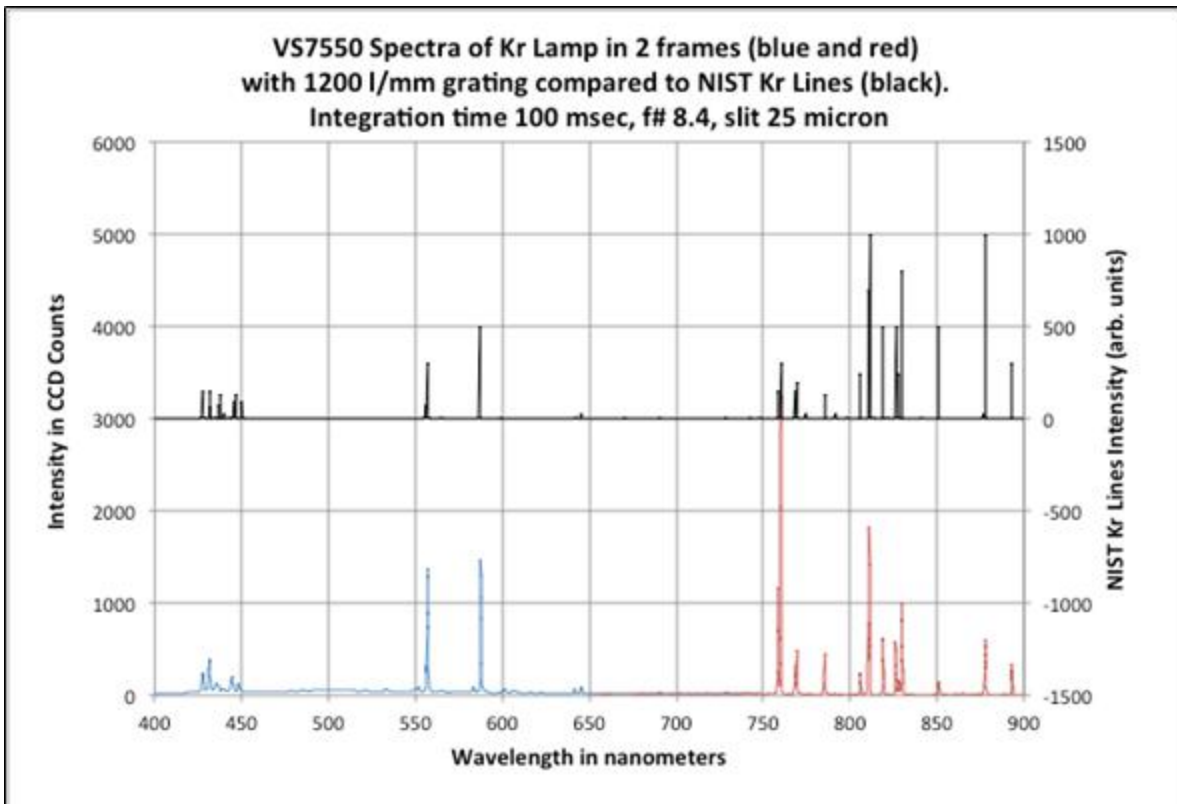
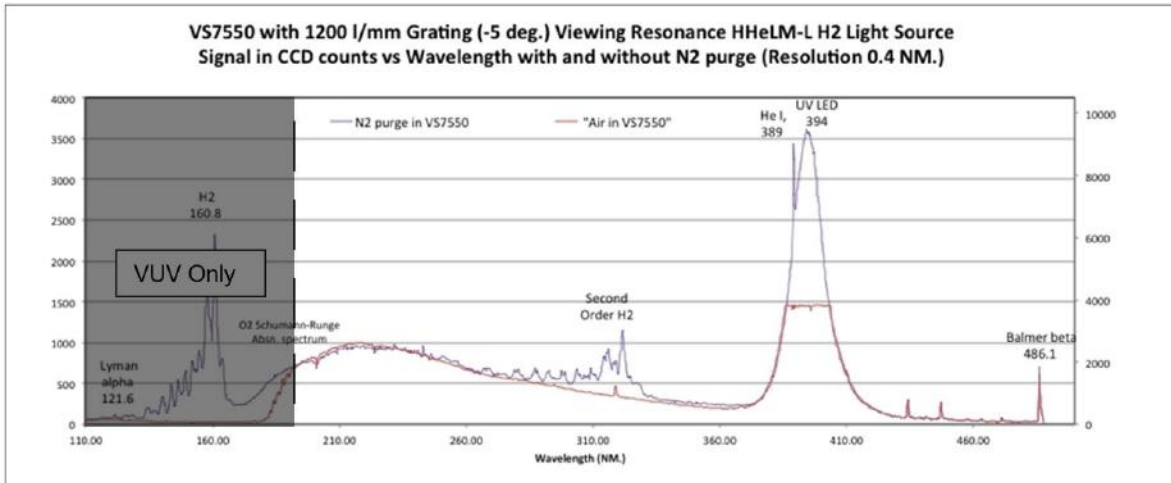

Contact

Resonance Ltd. stands behind every product we sell. We welcome feedback and encourage any of our customers to contact us with questions, or concerns. You may contact us through e-mail, our website, telephone, or fax!

Resonance Ltd.
143 Ferndale Drive North
Barrie, ON
L4N 9V9

Tel: 705-733-3633
Fax: 705-733-1388
Email: res@resonance.on.ca
Web: www.resonance.on.ca
